



CR03AM-16 1.25A Sensitive SCR

Rev.A.1.0

DESCRIPTION:

The CR03AM-16 SCR provides high dV/dt rate with strong resistance to electromagnetic interface. It is especially recommended for use on residual current circuit breaker, straight hair, igniter etc. Package SOT-223 is RoHS compliant.

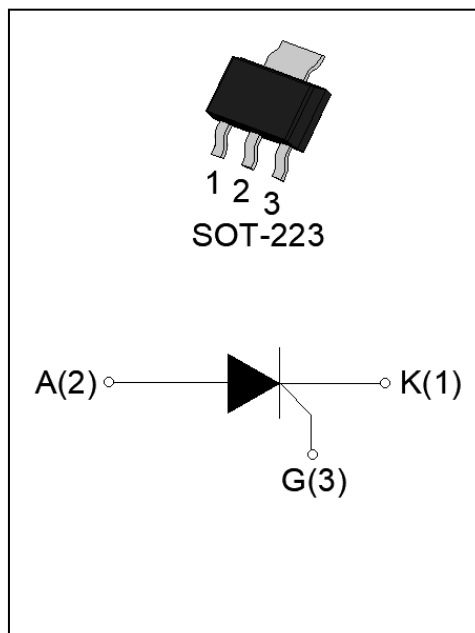

MAIN FEATURES

Symbol	Value	Unit
$I_{T(RMS)}$	1.25	A
V_{DRM} / V_{RRM}	1250	V
I_{GT}	≤ 200	μA

ABSOLUTE MAXIMUM RATINGS

Parameter	Symbol	Value	Unit
Storage junction temperature range	T_{stg}	-40-150	$^{\circ}C$
Operating junction temperature range	T_j	-40-110	$^{\circ}C$
Repetitive peak off-state voltage ($T_j=25^{\circ}C$)	V_{DRM}	1250	V
Repetitive peak reverse voltage ($T_j=25^{\circ}C$)	V_{RRM}	1250	V
Average on-state current ($T_c \leq 80^{\circ}C$)	$I_{T(AV)}$	0.8	A
RMS on-state current ($T_c \leq 80^{\circ}C$)	$I_{T(RMS)}$	1.25	A
Non repetitive surge peak on-state current ($t_p=10ms, T_j=25^{\circ}C$)	I_{TSM}	25	A
Non repetitive surge peak on-state current ($t_p=8.3ms, T_j=25^{\circ}C$)		28	
I^2t value for fusing ($t_p=10ms, T_j=25^{\circ}C$)	I^2t	3.1	A^2s
Critical rate of rise of on-state current ($I_G=2 \times I_{GT}, f=100Hz, T_j=110^{\circ}C$)	di/dt	100	$A/\mu s$
Peak gate current ($t_p=20\mu s, T_j=110^{\circ}C$)	I_{GM}	1.2	A
Average gate power dissipation ($T_j=110^{\circ}C$)	$P_{G(AV)}$	0.2	W

Peak gate power	P_{GM}	2	W
Peak pulse voltage ($T_j=25^\circ\text{C}$; non-repetitive, off-state; FIG.8)	V_{pp}	1	kV

ELECTRICAL CHARACTERISTICS ($T_j=25^\circ\text{C}$ unless otherwise specified)

Symbol	Test Condition	Value			Unit
		MIN.	TYP.	MAX.	
I_{GT}	$V_D=12\text{V}$ $R_L=33\Omega$	-	50	200	μA
V_{GT}		-	0.6	0.8	V
V_{GD}	$V_D=V_{DRM}$ $T_j=110^\circ\text{C}$	0.2	-	-	V
I_L	$I_G=1.2 I_{GT}$	-	-	5	mA
I_H	$I_T=0.05\text{A}$	-	-	4	mA
dV/dt	$V_D=800\text{V}$ $T_j=110^\circ\text{C}$ $R_{GK}=1\text{K}\Omega$	400	-	-	V/ μs
	$V_D=800\text{V}$ $T_j=110^\circ\text{C}$ $R_{GK}=220\Omega$	1000	-	-	
t_{on}	$I_G=10\text{mA}$ $I_A=20\text{mA}$ $I_R=2\text{mA}$	-	2	-	μs
t_{off}	$T_j=25^\circ\text{C}$	-	50	-	μs

STATIC CHARACTERISTICS

Symbol	Parameter		Value(MAX.)	Unit
V_{TM}	$I_T=2\text{A}$ $t_p=380\mu\text{s}$	$T_j=25^\circ\text{C}$	1.3	V
V_{TO}	Threshold voltage	$T_j=110^\circ\text{C}$	0.8	V
R_D	Dynamic Resistance	$T_j=110^\circ\text{C}$	0.2	Ω
I_{DRM}	$V_D=V_{DRM}$ $V_R=V_{RRM}$	$T_j=25^\circ\text{C}$	5	μA
I_{RRM}		$T_j=110^\circ\text{C}$	0.3	mA

THERMAL RESISTANCES

Symbol	Parameter	Value	Unit
$R_{th(j-c)}$	junction to case (DC)	20	$^\circ\text{C/W}$
$R_{th(j-a)}$	junction to ambient (DC)	150	$^\circ\text{C/W}$

MARKING

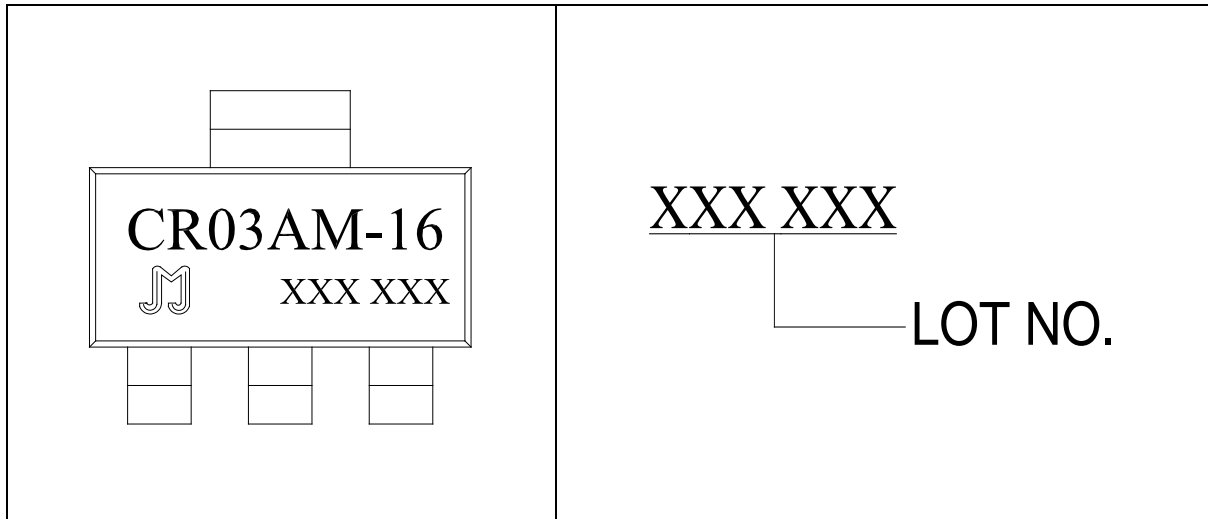

FIG.1 Maximum power dissipation versus RMS on-state current

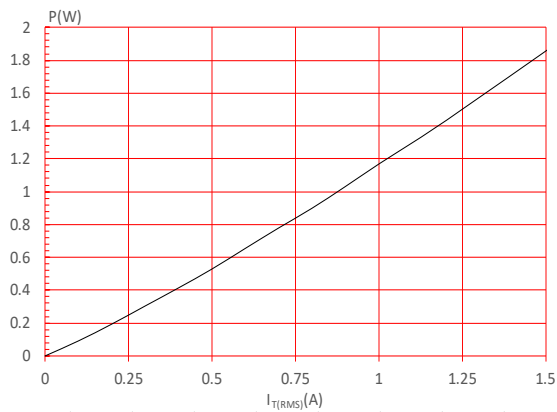

FIG.2: RMS on-state current versus case temperature

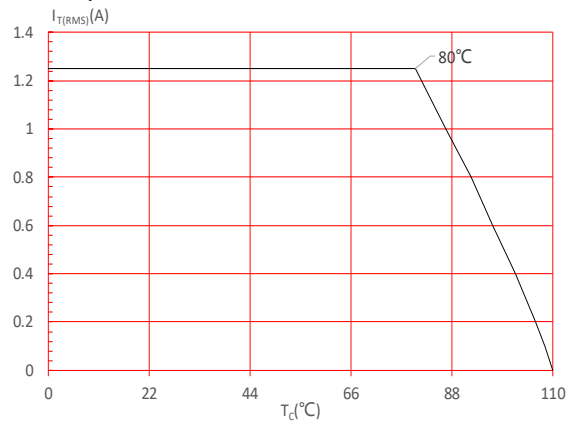

FIG.3: RMS on-state current versus ambient temperature (printed circuit board FR4,copper thickness:35μm)(full cycle)

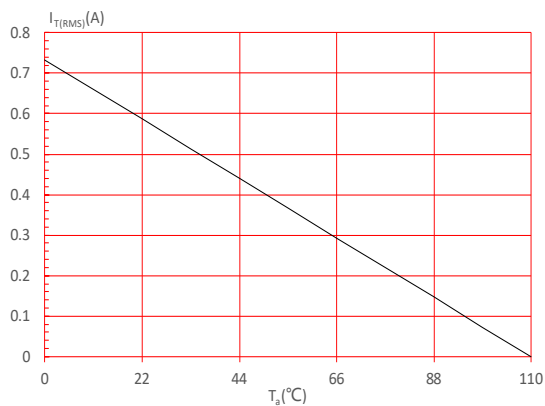

FIG.4: Surge peak on-state current versus number of cycles

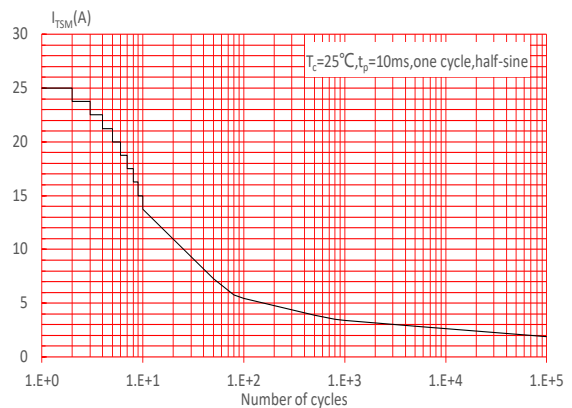

FIG.5: On-state characteristics

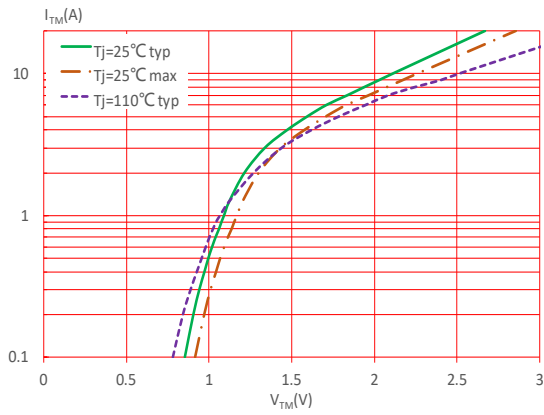

FIG.6: Non-repetitive surge peak on-state current for a sinusoidal pulse with width $t_p < 10\text{ms}$, and corresponding value of I^2t ($di/dt < 100\text{A}/\mu\text{s}$)

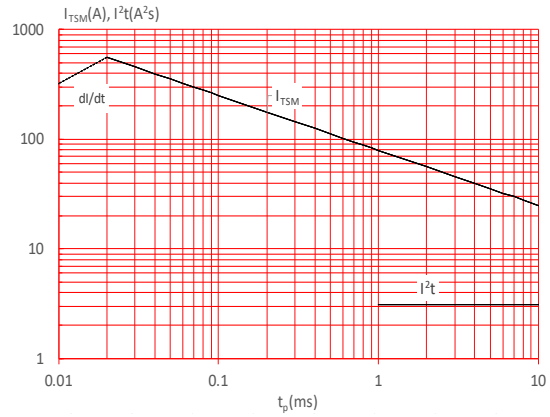

FIG.7: Relative variations of gate trigger current, holding current and latching current versus junction temperature

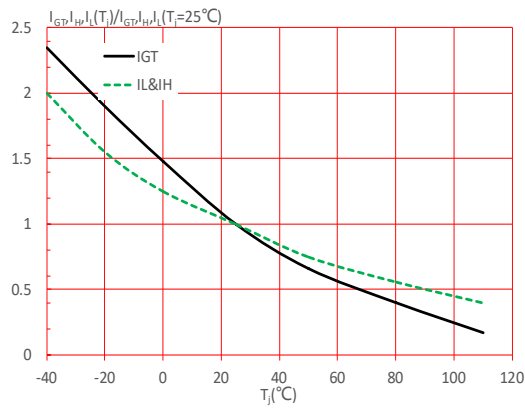
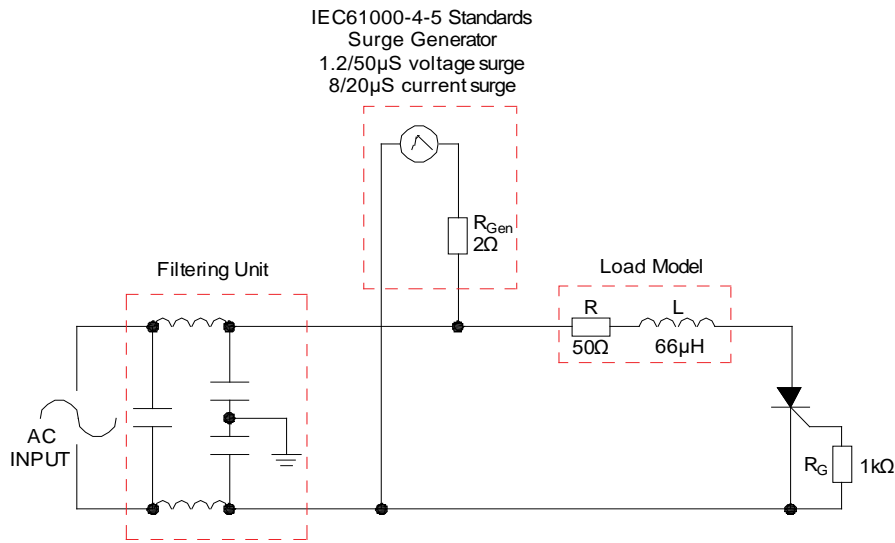
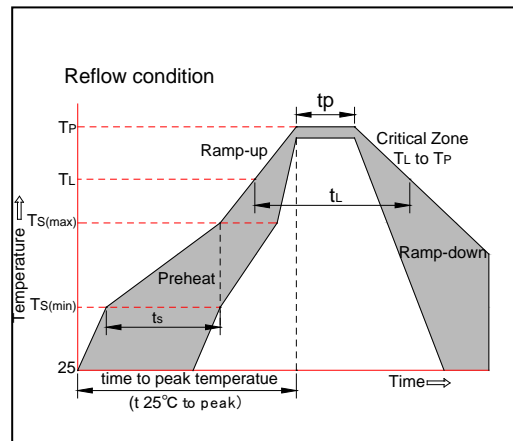

FIG.8: Test circuit for inductive and resistive loads to IEC-61000-4-5 standards.



SOLDERING PARAMETERS

Reflow Condition		Pb-Free assembly (see figure at right)
Pre Heat	-Temperature Min ($T_{s(min)}$)	+150°C
	-Temperature Max ($T_{s(max)}$)	+200°C
	-Time (Min to Max) (t_s)	60-180 secs.
Average ramp up rate (Liquidus Temp (T_L) to peak)		3°C/sec. Max
$T_{s(max)}$ to T_L - Ramp-up Rate		3°C/sec. Max
Reflow	-Temperature(T_L) (Liquidus)	+217°C
	-Temperature(t_L)	60-150 secs.
Peak Temp (T_p)		+260(+0/-5)°C
Time within 5°C of actual Peak Temp (t_p)		20-40secs.
Ramp-down Rate		6°C/sec. Max
Time 25°C to Peak Temp (T_p)		8 min. Max
Do not exceed		+260°C



ORDERING INFORMATION

Order code	Voltage V_{DRM}/V_{RRM} (V)	IGT(μ A)	Package	Base qty. (pcs)	Delivery mode
CR03AM-16	1250	≤ 200	SOT-223	4,000	Tape & Reel

Document Revision History

Date	Revision	Changes
Apr.12, 2023	A.1.0	Last update

PACKAGE MECHANICAL DATA

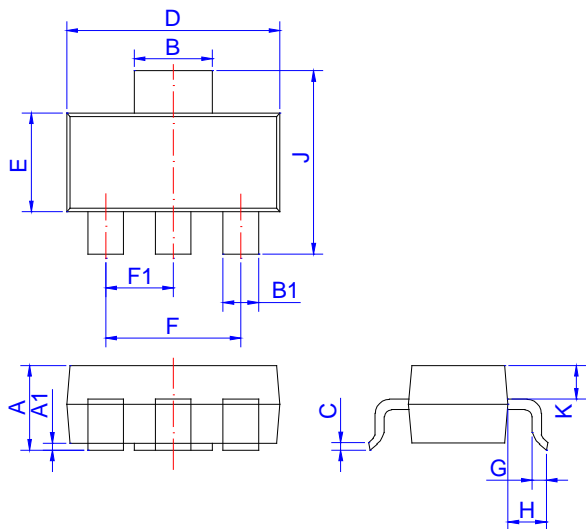

Ref.	Dimensions					
	Millimeters			Inches		
	Min.	Typ.	Max.	Min.	Typ.	Max.
A	1.5	1.6	1.8	0.059	0.063	0.071
A1	0.01	0.06	0.10	0.001	0.002	0.004
B	2.9	3.0	3.1	0.114	0.118	0.122
B1	0.6	0.7	0.8	0.024	0.028	0.031
C	0.22	0.26	0.32	0.009	0.010	0.013
D	6.3	6.5	6.7	0.248	0.256	0.264
E	3.3	3.5	3.7	0.130	0.138	0.146
F	4.4		4.8	0.173		0.189
F1	2.2		2.4	0.087		0.094
G	0.5		1.0	0.020		0.039
H	1.5	1.75	2.0	0.059	0.069	0.079
J	6.7	7.0	7.3	0.264	0.276	0.287
K	0.8	0.9	1.0	0.031	0.035	0.039

FOOTPRINT-SOT-223 (dimensions in mm)

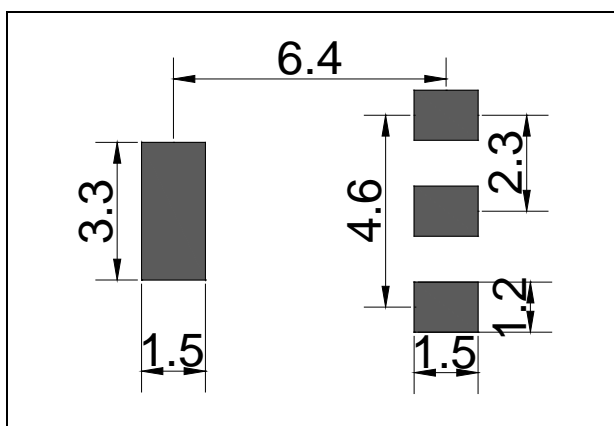

DELIVERY MODE

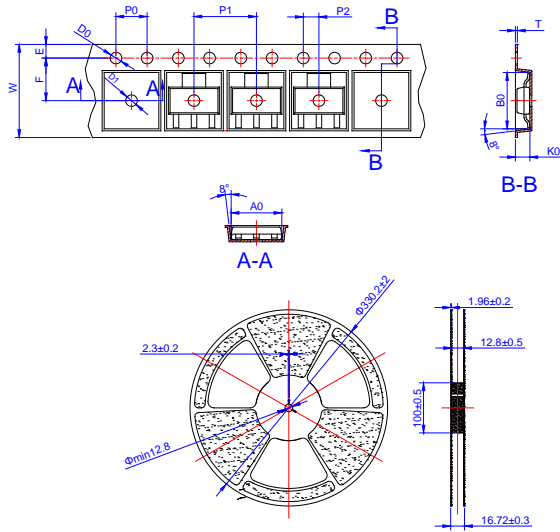

Ref.	Dimensions					
	Millimeters			Inches		
	Min.	Typ.	Max.	Min.	Typ.	Max.
W	-	-	12.30	-	-	0.482
E	1.65	1.75	1.85	0.065	0.069	0.073
F	5.45	5.50	5.55	0.215	0.217	0.219
D0	1.50	1.55	1.60	0.059	0.061	0.063
D1	1.50	-	-	0.059	-	-
P0	3.90	4.00	4.10	0.154	0.157	0.161
P1	7.90	8.00	8.10	0.311	0.315	0.319
P2	1.95	2.00	2.05	0.077	0.079	0.081
10P0	39.80	40.00	40.20	1.567	1.575	1.583
A0	6.85	6.95	7.05	0.269	0.273	0.276
B0	7.15	7.25	7.35	0.280	0.284	0.288
K0	1.95	2.05	2.15	0.076	0.080	0.084
T	0.20	0.25	0.30	0.008	0.010	0.012

PACKAGE	OUTLINE	REEL (PCS)	PER CARTON (PCS)	TAPE & REEL
SOT-223	TAPING	4,000	40,000	13 inch

Information furnished in this document is believed to be accurate and reliable. However, Jiangsu JieJie Microelectronics Co., Ltd. assumes no responsibility for the consequences of use without consideration for such information nor use beyond it. Information mentioned in this document is subject to change without notice, apart from that when an agreement is signed, Jiangsu JieJie complies with the agreement. Products and information provided in this document have no infringement of patents. Jiangsu JieJie assumes no responsibility for any infringement of other rights of third parties which may result from the use of such products and information. This document supersedes and replaces all information previously supplied.

 is a registered trademark of Jiangsu JieJie Microelectronics Co., Ltd.
Copyright ©2023 Jiangsu JieJie Microelectronics Co., Ltd. All rights reserved.